

4

3

2

1

A

B

C

D

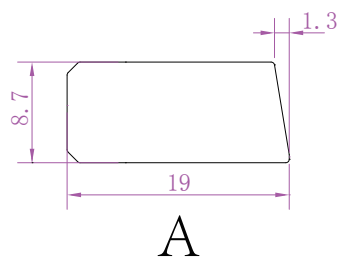
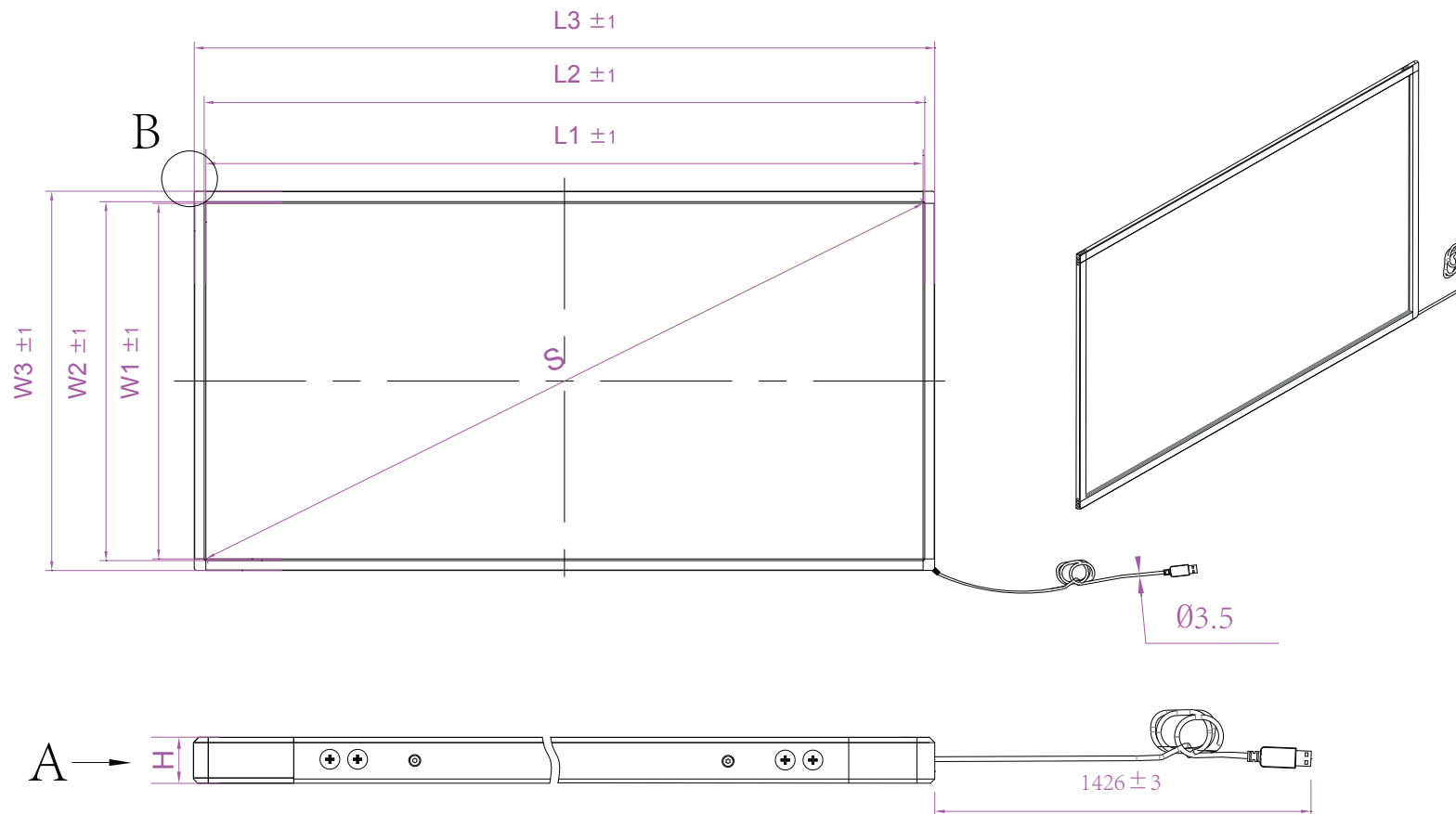
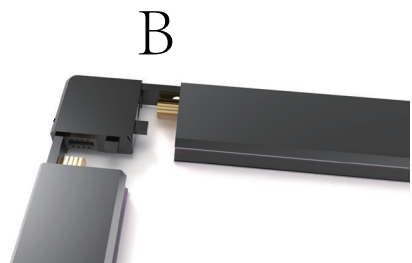

S(Inch/mm)	27.16"/690.07
W1	336.8 ± 1
W2	339.4 ± 1
W3	374.8 ± 1
L1	602.3 ± 1
L2	604.9 ± 1
L3	640.3 ± 1
H	8.7 ± 0.2



Anti-Sunlight, No Blind Zone For Any Size



Master Touch 		MST-IR-TF-27					
Material:	aluminum	Unit:	mm	Date:		Rev:	1.0
Draft by:		Approved by:					

4

3

2

1