

4

3

2

1

A

B

C

D

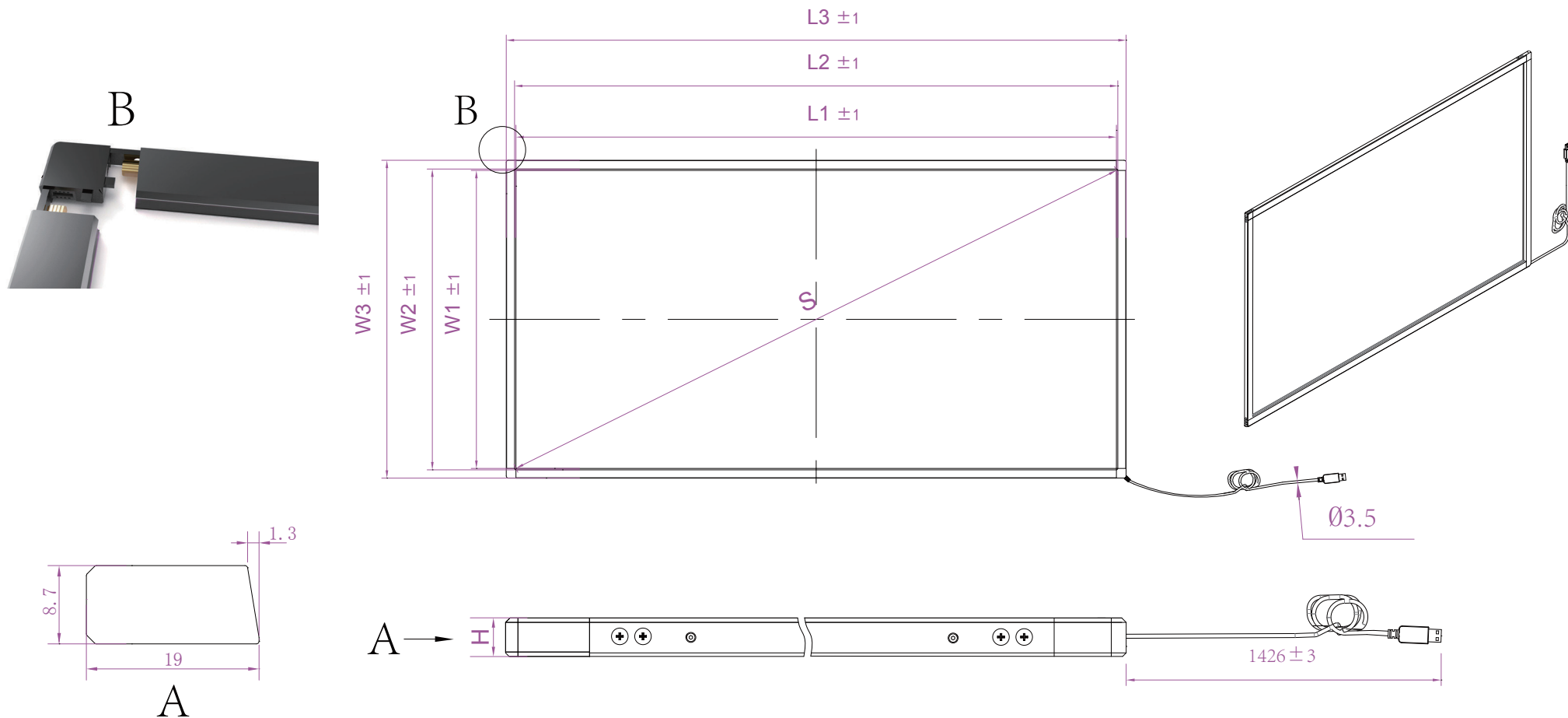

S(Inch/mm)	42.66"/1083.78
W1	531.5 ± 1
W2	534.1 ± 1
W3	569.5 ± 1
L1	944.5 ± 1
L2	947.1 ± 1
L3	982.5 ± 1
H	8.7 ± 0.2



Anti-Sunlight, No Blind Zone For Any Size



Master Touch 		MST-IR-TF-43	
Material:	aluminum	Unit:	mm
Date:		Rev:	1.0
Draft by:		Approved by:	

4

3

2

1