

4

3

2

1

A

B

C

D

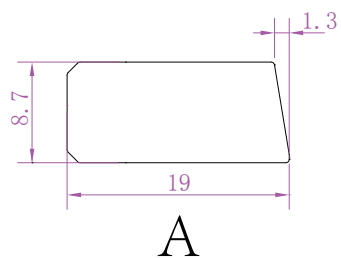
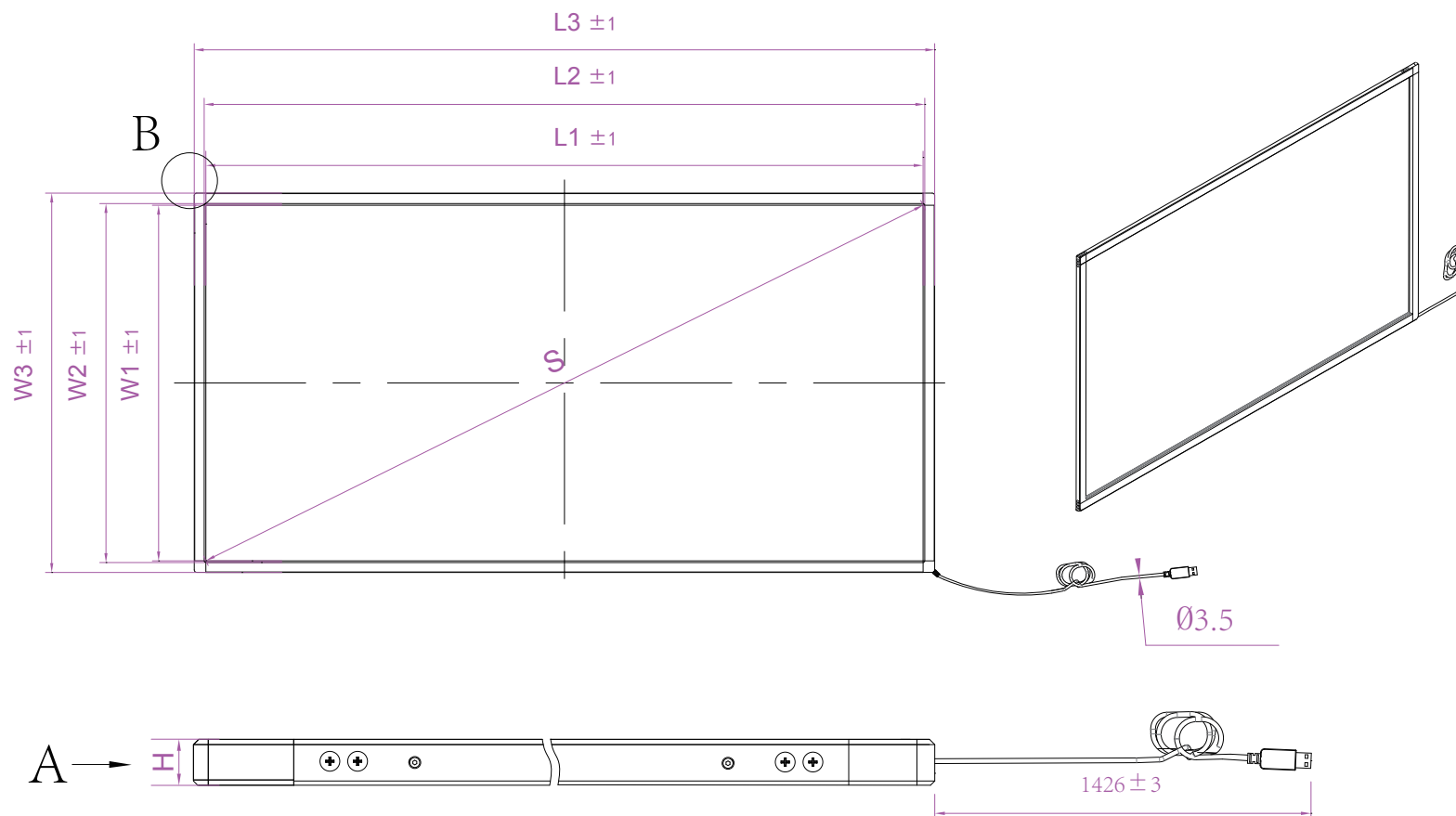
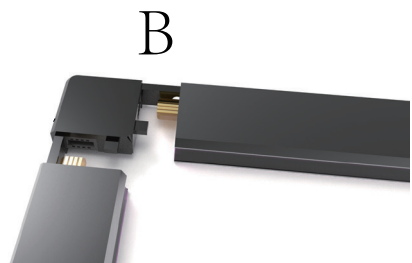

S(Inch/mm)	47.24"/1200.12
W1	590.5 ± 1
W2	593.1 ± 1
W3	628.5 ± 1
L1	1044.8 ± 1
L2	1047.4 ± 1
L3	1082.8 ± 1
H	8.7 ± 0.2



Anti-Sunlight, No Blind Zone For Any Size



Master Touch 		MST-IR-TF-47					
Material:	aluminum	Unit:	mm	Date:		Rev:	1.0
Draft by:				Approved by:			

4

3

2

1