

4

3

2

1

A

B

C

D

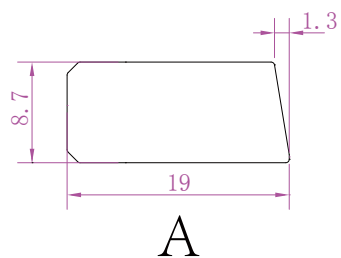
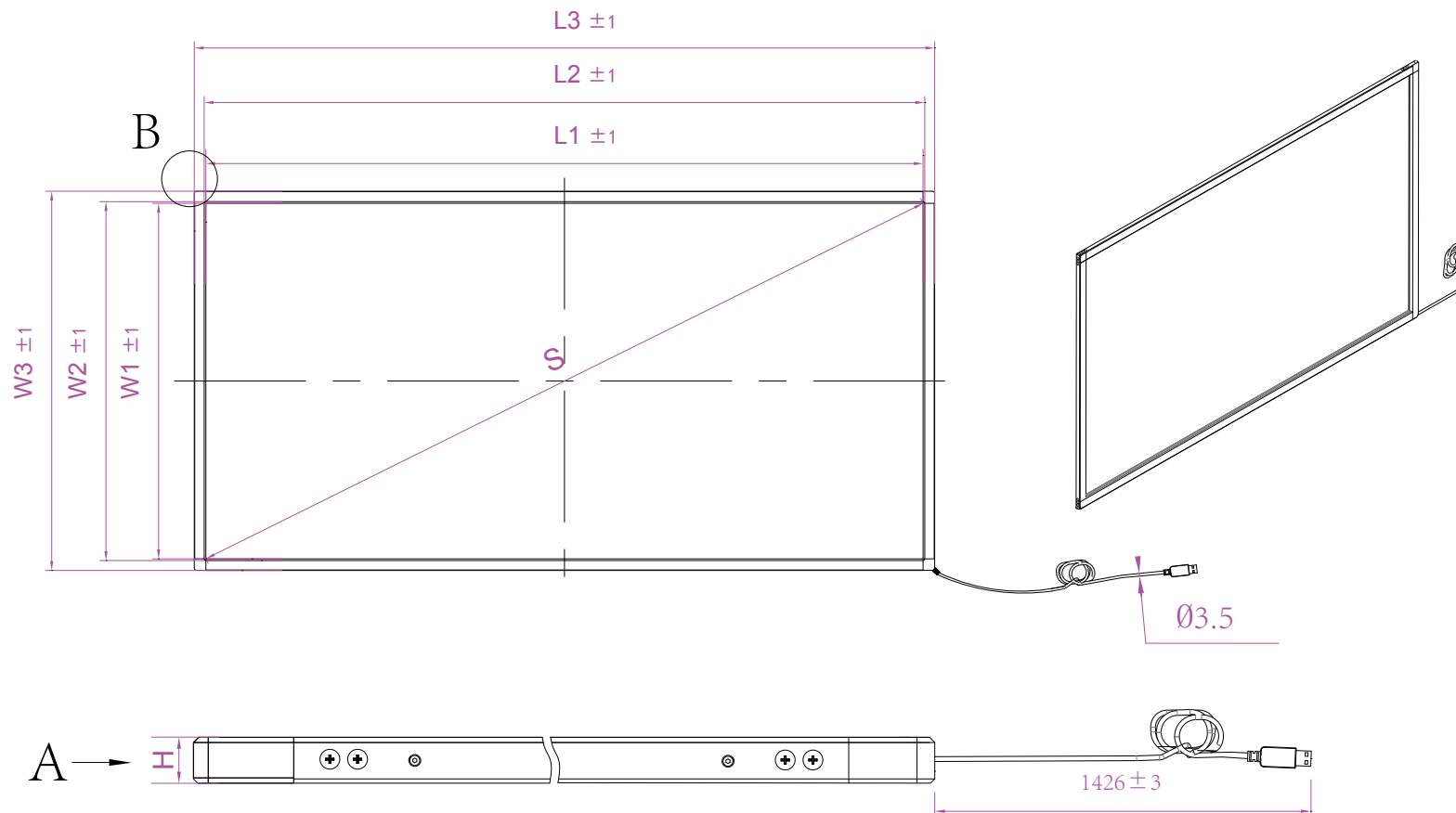
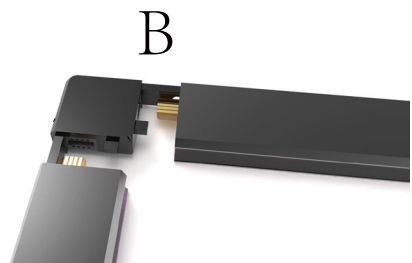

S(Inch/mm)	49.64"/1260.86
W1	620.0 ±1
W2	622.6 ±1
W3	658.0 ±1
L1	1097.9 ±1
L2	1100.5 ±1
L3	1135.9 ±1
H	8.7 ±0.2



Anti-Sunlight, No Blind Zone For Any Size



Master Touch 		MST-IR-TF-50					
Material:	aluminum	Unit:	mm	Date:		Rev:	1.0
Draft by:				Approved by:			

4

3

2

1